

CASED SAMPLING SYSTEM

RAMBO S

Ø 115 mm / Ø 100 mm / Ø 85 mm

Metric liner system for undisturbed
soil samples

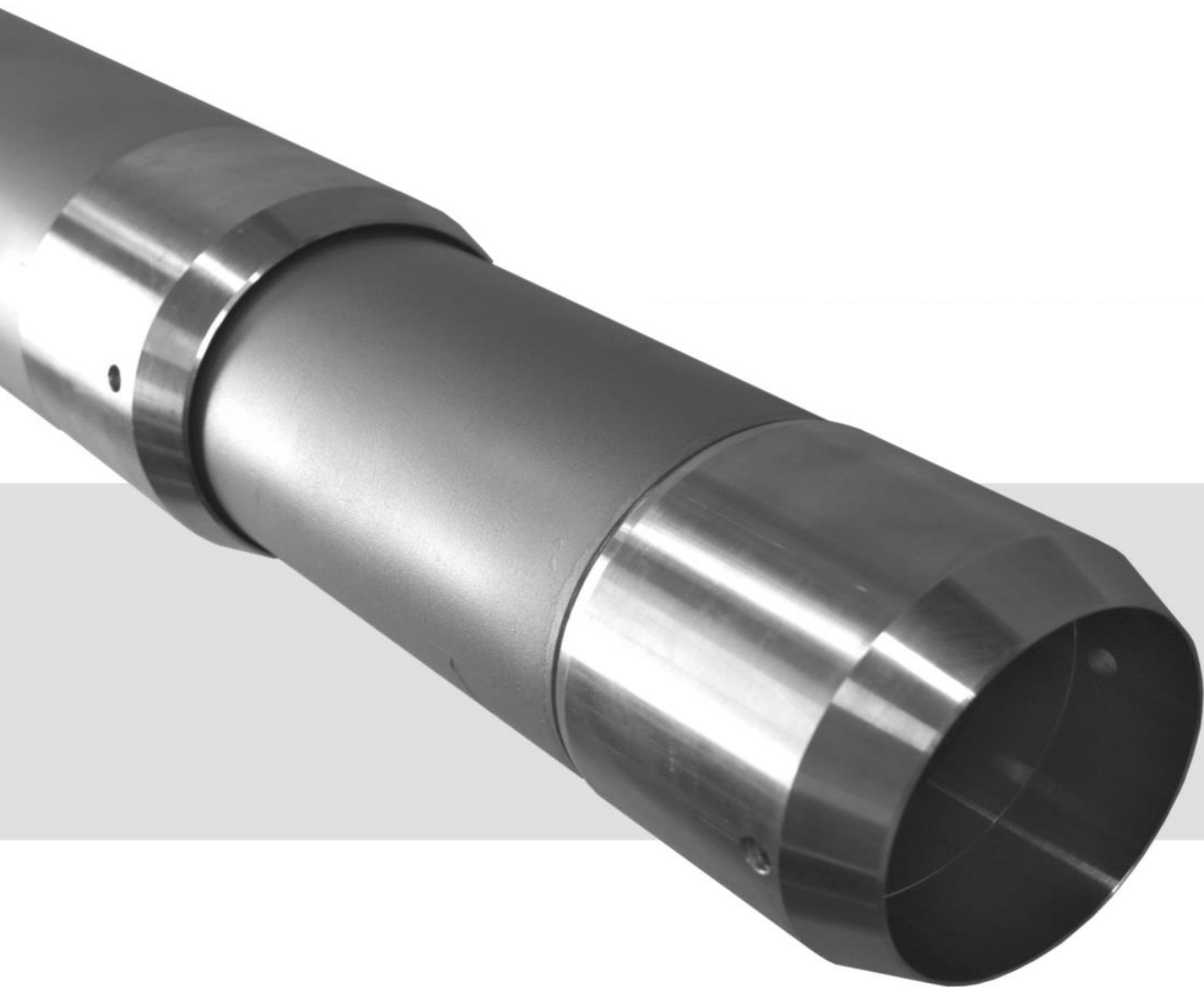

SYSTEM SIZE Ø-115 / OVERVIEW	3
SYSTEM SIZE Ø-115 / ARTICLES	4
SYSTEM SIZE Ø-115 / CASING	5
SYSTEM SIZE Ø-115 / LINER TUBE	6
SYSTEM SIZE Ø-115 / CLAMPS & ACCESSORIES	7
SYSTEM SIZE Ø-100 / OVERVIEW	9
SYSTEM SIZE Ø-100 / ARTICLES	10
SYSTEM SIZE Ø-100 / CASING	11
SYSTEM SIZE Ø-100 / LINER TUBE	12
SYSTEM SIZE Ø-100 / CLAMPS & ACCESSORIES	13
SYSTEM SIZE Ø-85 / OVERVIEW	15
SYSTEM SIZE Ø-85 / ARTICLES	16
SYSTEM SIZE Ø-85 / CASING	17
SYSTEM SIZE Ø-85 / LINER TUBE	18
SYSTEM SIZE Ø-85 / CLAMPS & ACCESORIES	19
ACCESSORIES ALL DIAMETERS	21
PHOTOS	23

SYSTEM SIZE Ø-115 / OVERVIEW

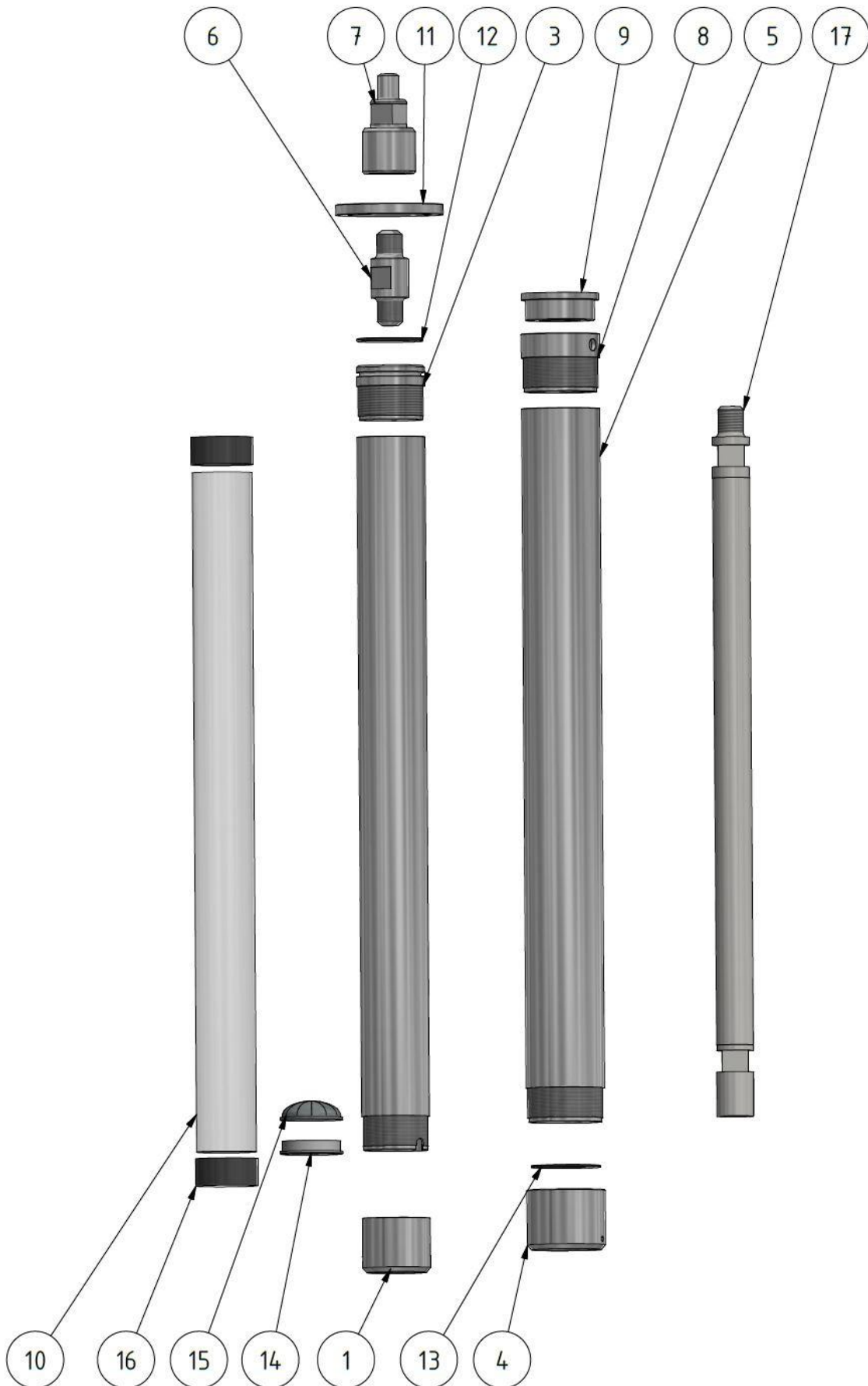

SYSTEM SIZE Ø-115 / ARTICLES

Pos.	Description	Article
1	Cutting shoe Ø 100	702003
2	Extension tube Ø 100 x 1.000 mm	702006
3	Screw head Ø 100 mm	702009
4	Cutting shoe Ø 115 mm with O-Ring	702016
5	Protection tube Ø 115 x 1.000 mm	702015
6	Double nipple	335095
7	Impact head	335300
8	Protective screw attachment Ø 115 mm	702017
9	Impact plate Ø 115 mm	702018
10	Liner Ø 87 mm	338006
11	Draw plate for Ø 115 mm	702019
12	O-Ring for screw head Ø 100 mm	702035
13	O-Ring for cutting shoe Ø 100 mm	702032
14	Protective ring for liner Ø 87 mm	702012
15	PE core catcher for liner Ø 87 mm	338008
16	PE-caps for liner Ø 87 mm	312519
17	Probe rod Ø 54 x 1.000 mm	335094

SYSTEM SIZE Ø-115 / CASING

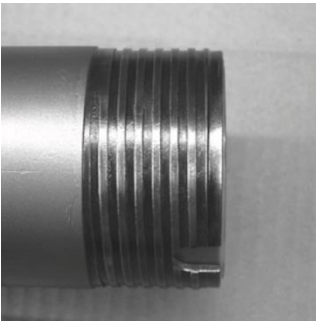

702015 **Protection tube** Ø 115 x 1.000 mm
OD 115 mm / ID 103 mm
Casing in the borehole as protection against falling



702016 **Cutting shoe** Ø 115 mm with O-Ring
O-Ring inside
O-Ring dseals against the cutting shoe of the liner probe



702017 **Protective screw attachment** Ø 115 mm
Protects threads from dirt
Protects threads against the impact energy



702018 **Impact plate** Ø 115 mm
Absorbs the impact energy of the impact head and passes it on to the protective piping



702019 **Draw plate** for Ø 115 mm
Complete diameter 160 mm
Diameter groove 115 mm
Passage 103 mm
For pulling the liner while the protective piping remains in the ground

SYSTEM SIZE Ø-115 / LINER TUBE



702000 **Liner probe** Ø 100 x 1.000 mm complete / OD 100 mm / ID 90 mm
 Extension tube 100 x 1.000 mm (702006)
 Cutting shoe 100 mm with inside O-Ring (702003)
 Screw head 100 mm with outside O-Ring (702009)
 Protective ring for liner 88 mm (702012)

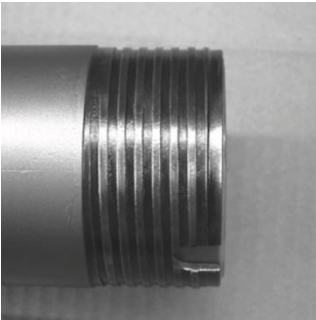

702006 **Extension tube** Ø 100 x 1.000 mm
 OD 100 mm / ID 90 mm
 Part of liner probe complete (700200)

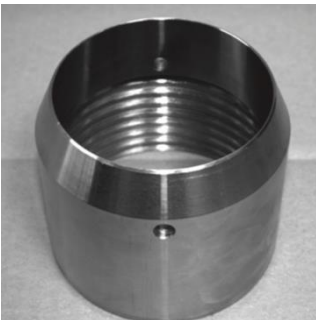

702003 **Cutting shoe** Ø 100 mm with O-Ring
 O-Ring inside
 Part of liner probe complete (700200)

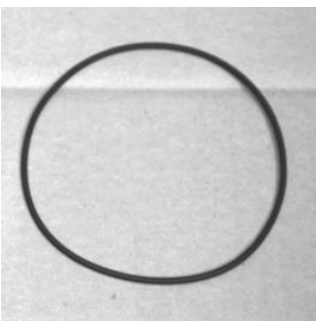

702031 **O-Ring** for cutting shoe Ø 115 mm
 Inserted in cutting shoe Ø 100 mm (702003)



702009 **Screw head** Ø 100 mm
 O-Ring protects inlet air hole
 Part of liner probe complete (700200)

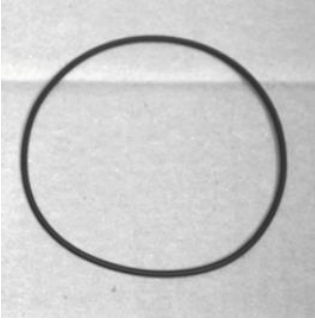

702035 **O-Ring for screw head** Ø 100 mm
Inserted in screw head Ø 100 mm (702009)
O-Ring protects inlet air hole



702012 **Protective ring** for liner Ø 88 mm
Protects the edge of the liner from stony cuttings
Part of liner probe complete (700200)

SYSTEM SIZE Ø-115 / CLAMPS & ACCESSORIES



333038 **Wheel clamp** Ø 22 – 65 mm
For pulling the probe rod



702006 **Ball clamp** Ø 115 – 130 mm
For pulling the protective piping



338008 **PE core catcher** for liner Ø 88 mm
Replaces protection ring (702012)
To catch a core sample in permeable soil

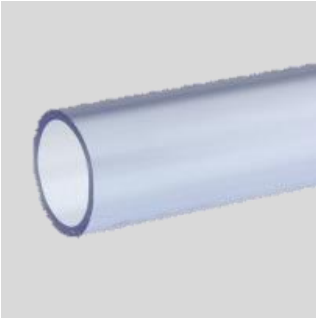

338006 **Liner** Ø 88 mm
To take an undisturbed soil sample

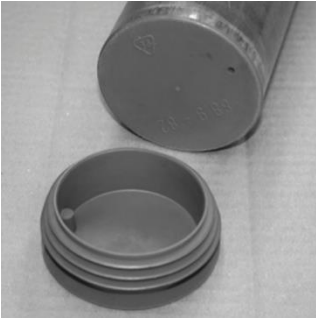

312519 **PE-caps for liner** Ø 88 mm
100 pieces
Two-tone 50/50 for marking the beginning and end of the sample

SYSTEM SIZE Ø-100 / OVERVIEW

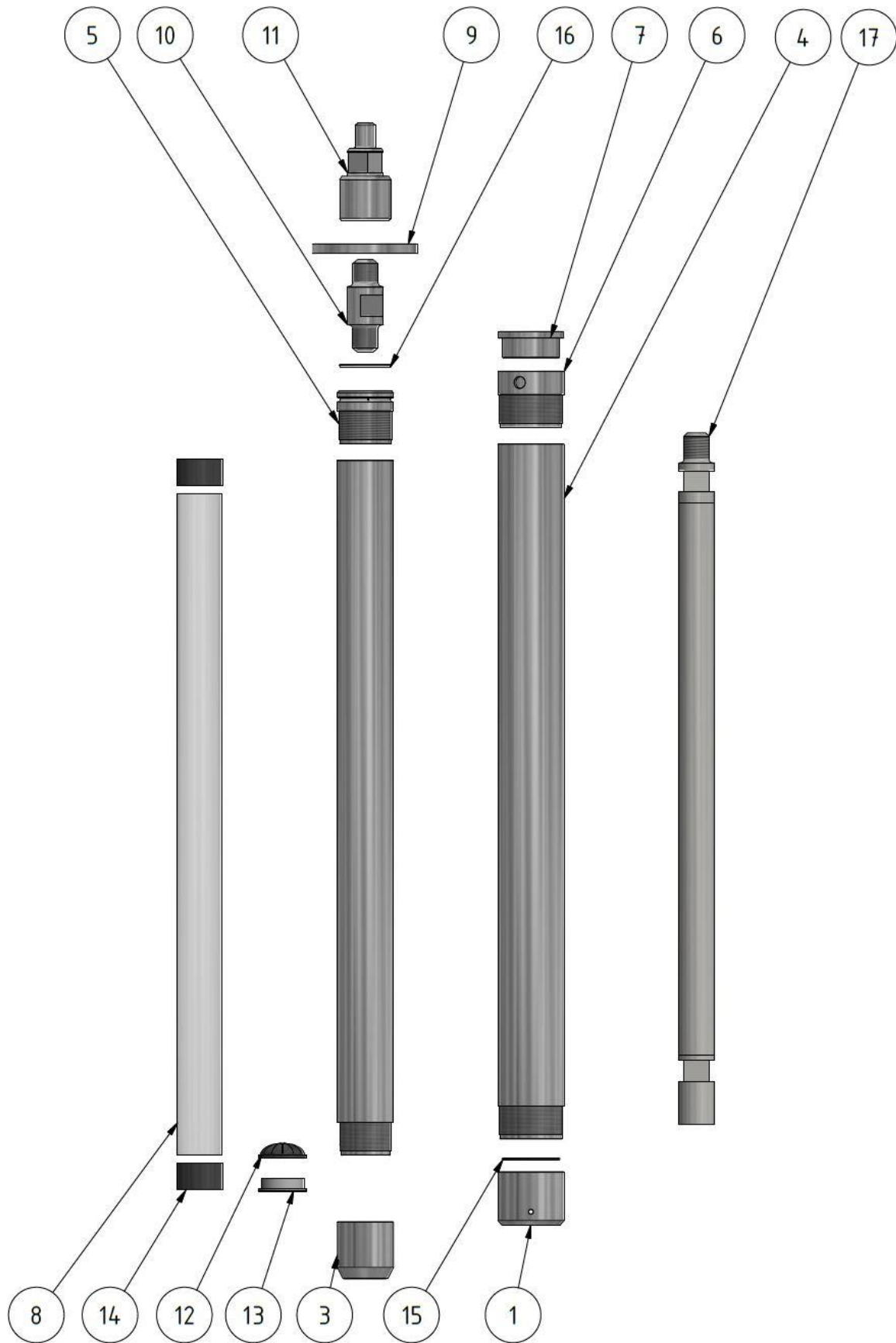

SYSTEM SIZE Ø-100 / ARTICLES

Pos.	Description	Article
1	Cutting shoe Ø 100	702003
2	Extension tube Ø 85 x 1.000 mm	702007
3	Cutting shoe Ø 85 mm	702004
4	Extension tube Ø 100 x 1.000 mm	702006
5	Screw head Ø 85 mm	702010
6	Protective screw attachment Ø 100 mm	702020
7	Impact plate Ø 85 mm	702024
8	Liner Ø 65 mm	335205
9	Draw plate for Ø 100 mm	702022
10	Double nipple	335095
11	Impact head	335300
12	PE core catcher for liner Ø 65 mm	335308
13	Protective ring for liner Ø 65 mm	702013
14	PE-caps for liner Ø 65 mm	335214
15	O-Ring for cutting shoe Ø 100 mm	702032
16	O-Ring for screw head Ø 85 mm	702035
17	Probe rod Ø 54 x 1.000 mm	335094

SYSTEM SIZE Ø-100 / CASING

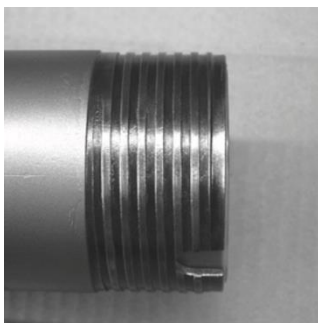

702006 **Protection tube** Ø 100 x 1.000 mm
OD 100 mm / ID 90 mm
Casing in the borehole as protection against falling

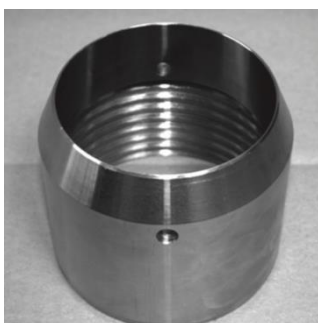

702003 **Cutting shoe** Ø 100 mm with O-Ring
O-Ring inside
O-Ring dseals against the cutting shoe of the liner probe

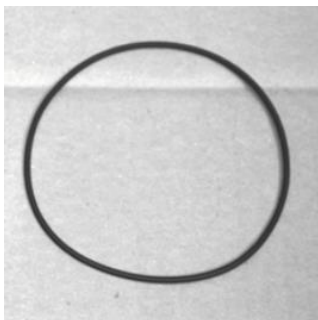

702032 **O-Ring** for cutting shoe Ø 100 mm
Inserted in cutting shoe Ø 100 mm (702003)
O-Ring seals against cutting shoe of the liner probe



702020 **Protective screw attachment** Ø 100 mm
Protects threads from dirt
Protects threads against the impact energy



702021 **Impact plate** Ø 100 mm
Absorbs the impact energy of the impact head and passes it on to the protective piping



- 702022 **Draw plate** for Ø 100 mm
Complete diameter 160 mm
Diameter groove 100 mm
Passage 90 mm
For pulling the liner while the protective piping remains in the ground

SYSTEM SIZE Ø-100 / LINER TUBE

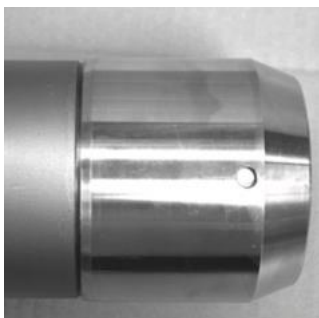

- 702001 **Liner probe** Ø 85 x 1.000 mm complete / OD 85 mm / ID 69 mm
Extension tube 85 x 1.000 mm (702007)
Cutting shoe 85 mm with inside O-Ring (702004)
Screw head 85 mm with outside O-Ring (702010)
Protective ring for liner 65 mm (702013)

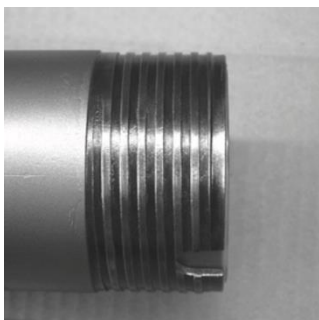

- 702007 **Extension tube** Ø 85 x 1.000 mm
OD 85 mm / ID 69 mm
Part of liner probe complete (700201)



- 702004 **Cutting shoe** Ø 85 mm with O-Ring
O-Ring inside
Part of liner probe complete (700201)

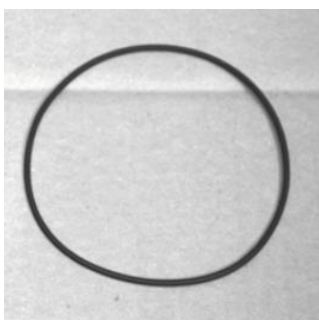

- 702034 **O-Ring** for cutting shoe Ø 85 mm
Inserted in cutting shoe Ø 85 mm (702004)



702010 **Screw head** Ø 85 mm
O-Ring protects inlet air hole
Part of liner probe complete (700201)

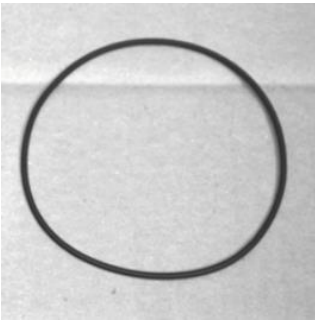

702033 **O-Ring for screw head** Ø 85 mm
Inserted in screw head Ø 85 mm (702010)
O-Ring protects inlet air hole

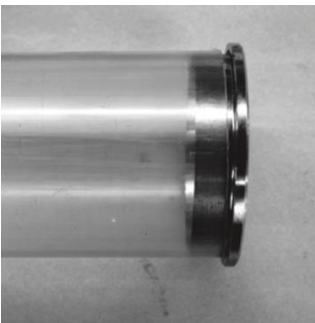

702013 **Protective ring** for liner Ø 65 mm
Protects the edge of the liner from stony cuttings
Part of liner probe complete (700201)

SYSTEM SIZE Ø-100 / CLAMPS & ACCESSORIES



333038 **Wheel clamp** Ø 22 – 65 mm
For pulling the probe rod



333006 **Ball clamp** Ø 95 – 108 mm
For pulling the protective piping



335308 **PE core catcher** for liner Ø 65 mm
Replaces protection ring (702013)
To catch a core sample in permeable soil

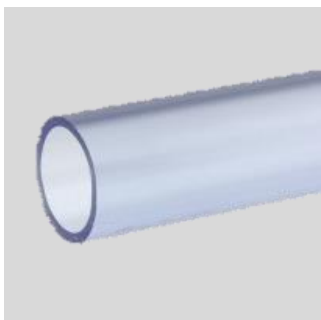

335205 **Liner Ø 65 mm**
To take an undisturbed soil sample

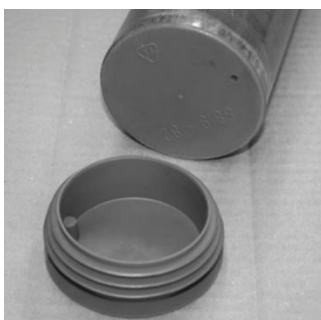

335214 **PE-caps for liner Ø 65 mm**
100 pieces
Two-tone 50/50 for marking the beginning and end of the sample

SYSTEM SIZE Ø-85 / OVERVIEW

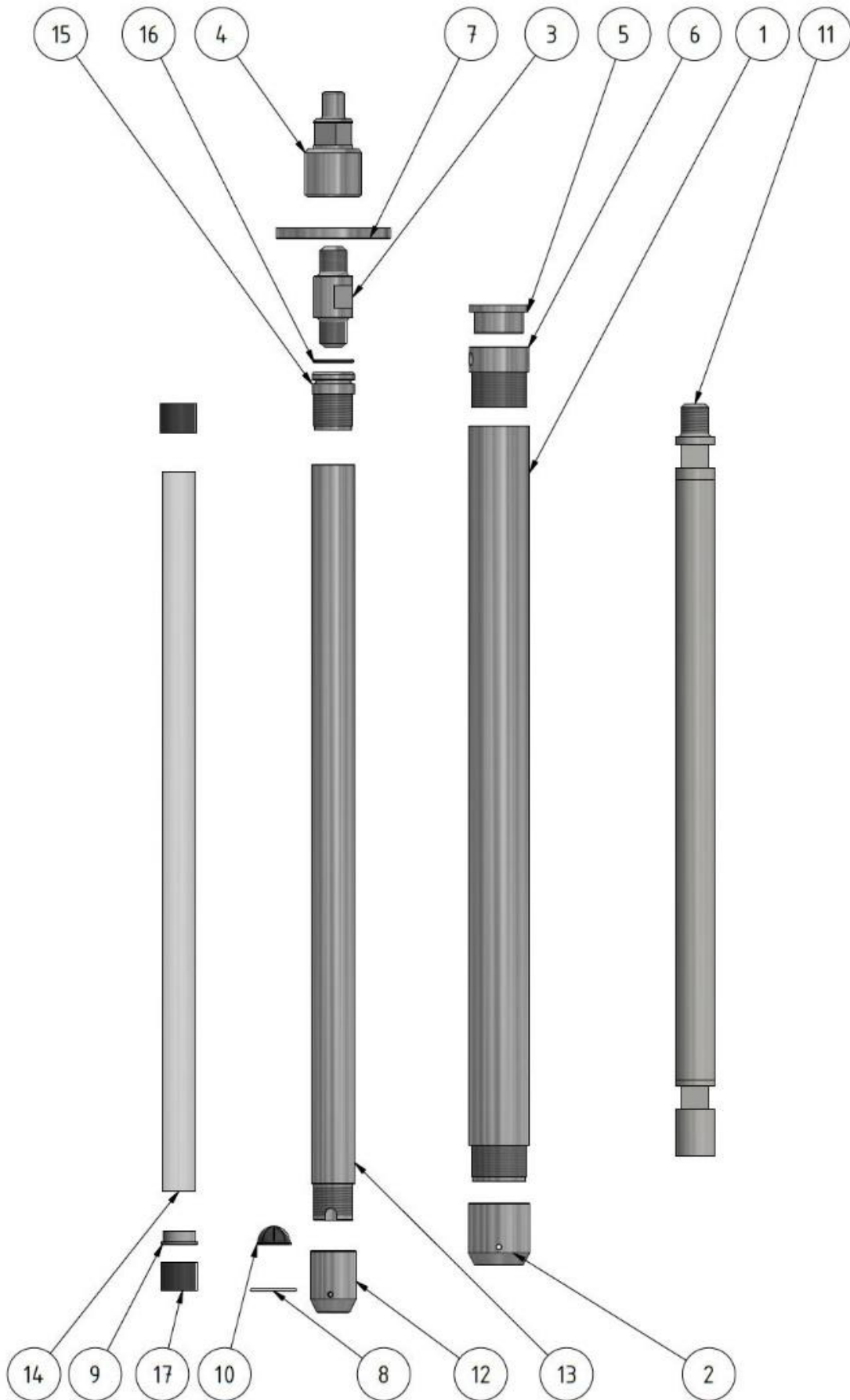

SYSTEM SIZE Ø-85 / ARTICLES

Pos.	Description	Article
1	Extension tube Ø 85 x 1.000 mm	702007
2	Cutting shoe Ø 85 mm	702004
3	Double nipple	335095
4	Impact head	335300
5	Impact plate Ø 85 mm	702024
6	Protective screw attachment Ø 85 mm	702023
7	Draw plate for Ø 85 mm	702025
8	O-Ring for cutting shoe Ø 85 mm	702034
9	Protective ring for liner Ø 46 mm	702014
10	PE core catcher for liner Ø 46 mm	335608
11	Probe rod Ø 54 x 1.000 mm	335094
12	Cutting shoe Ø 60 mm	702005
13	Extension tube Ø 60 x 1.000 mm	702008
14	Liner Ø 46 mm	335603
15	Screw head Ø 60 mm	702011
16	O-Ring for screw head Ø 60 mm	702037
17	PE-caps for liner Ø 46 mm	319107

SYSTEM SIZE Ø-85 / CASING

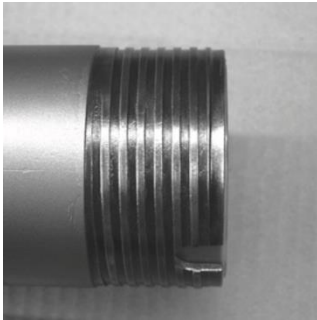

- 702007 **Protection tube** Ø 85 x 1.000 mm
OD 85 mm / ID 69 mm
Casing in the borehole as protection against falling



- 702004 **Cutting shoe** Ø 85 mm with O-Ring
O-Ring inside
O-Ring dseals against the cutting shoe of the liner probe

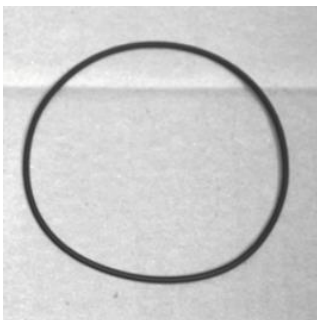

- 702034 **O-Ring** for cutting shoe Ø 85 mm
Inserted in cutting shoe Ø 85 mm (702004)
O-Ring seals against cutting shoe of the liner probe



- 702023 **Protective screw attachment** Ø 85 mm
Protects threads from dirt
Protects threads against the impact energy



- 702024 **Impact plate** Ø 85 mm
Absorbs the impact energy of the impact head and passes it on to the protective piping



702025 **Draw plate** for Ø 85 mm
Complete diameter 160 mm
Diameter groove 85 mm
Passage 69 mm
For pulling the liner while the protective piping remains in the ground

SYSTEM SIZE Ø-85 / LINER TUBE

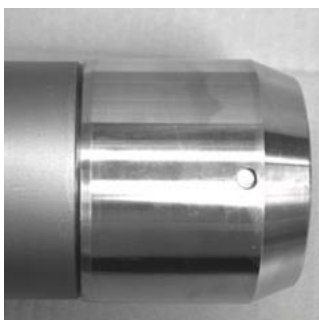

702002 **Liner probe** Ø 60 x 1.000 mm complete / OD 60 mm / ID 48 mm
Extension tube 60 x 1.000 mm (702008)
Cutting shoe 60 mm with inside O-Ring (702005)
Screw head 60 mm with outside O-Ring (702011)
Protective ring for liner 46 mm (702014)

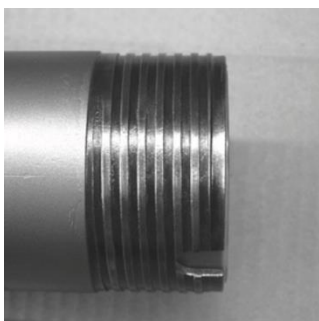

702008 **Extension tube** Ø 60 x 1.000 mm
OD 60 mm / ID 48 mm
Part of liner probe complete (700202)



702005 **Cutting shoe** Ø 60 mm with O-Ring
O-Ring inside
Part of liner probe complete (700202)



702011 **Screw head** Ø 60 mm
O-Ring protects inlet air hole
Part of liner probe complete (700202)

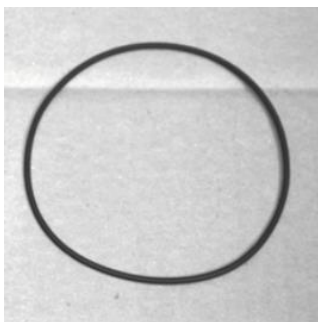

702037 **O-Ring for screw head** Ø 60 mm
Inserted in screw head Ø 85 mm (702011)
O-Ring protects inlet air hole



702014 **Protective ring** for liner Ø 46 mm
Protects the edge of the liner from stony cuttings
Part of liner probe complete (700202)

SYSTEM SIZE Ø-85 / CLAMPS & ACCESORIES



333038 **Wheel clamp** Ø 22 – 65 mm
For pulling the probe rod



333005 **Ball clamp** Ø 80 – 90 mm
For pulling the protective piping



335608 **PE core catcher** for liner Ø 46 mm
Replaces protection ring (702014)
To catch a core sample in permeable soil

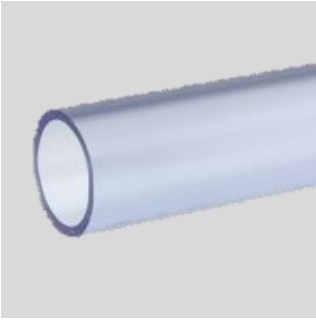

335603 **Liner** Ø 46 mm
To take an undisturbed soil sample

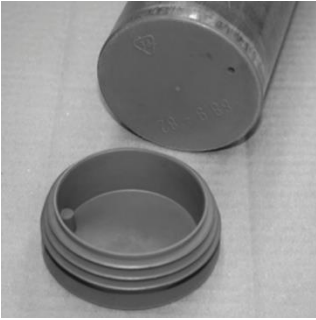

335006 **PE-caps for liner** Ø 46 mm
100 pieces
Two-tone 50/50 for marking the beginning and end of the sample

ACCESSORIES ALL DIAMETERS



- 335095 **Double nipple**
2 courses on Whitworth
Connects screw head with impact head and after the first meter with probing rod

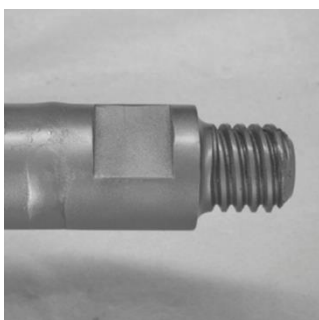

- 335094 **Probe rod** Ø 54 x 1.000 mm
2 thread inside/ outside
Extension rod for liner probe



- 336150 **Installation wrench** SW 39
Length 700 mm
For separating the probing rods and accessories



- 312179 **Chain pliers** 55 mm to 125 mm
To separate the protective piping



- 312068 **Tenon wrench** 50 mm to 120 mm
To loosen the cutting shoe



335093 **Impact head**
Inside Whitworth
Short version for the anvil brass piece
Absorption of the impact energy of the impact unit



371076 **Fork plate SW 39**
With hanging loop for which
Prevents the probe rod from slipping through
To remove the liner probe from the borehole



312416 **Thread lubricant**
Keeps the threads running at all times and protects against dirt



610341 **Wire brush**
To clean the threads

PHOTOS



Nordmeyer GEOTOOL Ltd.

Weststraße 6

16356 Werneuchen (Berlin Area)

GERMANY

Tel: +49 (0) 33398 9142-0

Email: info@nordmeyer-geotool.com